

# 5' DIA DOUBLE CATCH BASIN

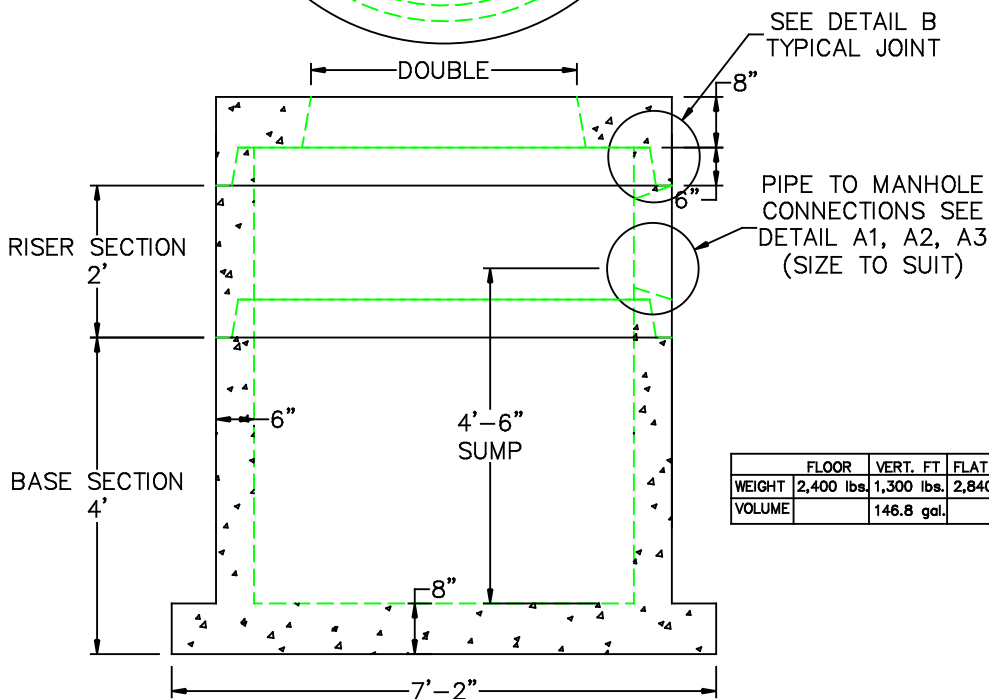

	FLOOR	VERT. FT	FLAT TOP
WEIGHT	2,400 lbs.	1,300 lbs.	2,840 lbs.
VOLUME		146.8 gal.	

A1  
COMPRESSION GASKET (CAST IN)

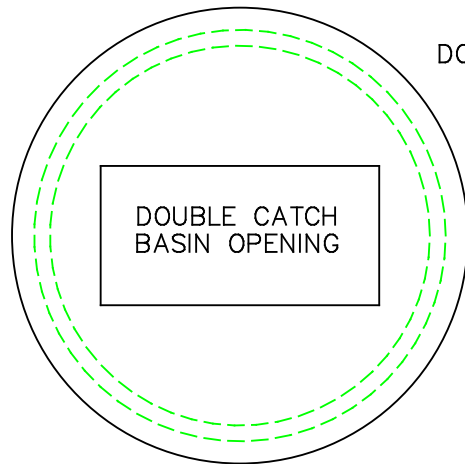
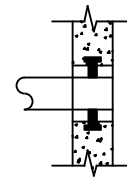

A2  
FLEXIBLE SLEEVE

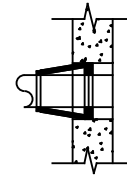

A3  
MORTAR BY CONTRACTOR

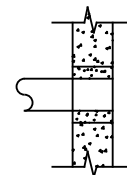

B  
BUTYL RUBBER SECTION JOINT

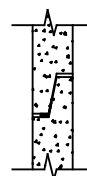

C  
POLYPROPYLENE MANHOLE STEPS

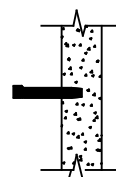

**DESIGN NOTES:**

1. MANUFACTURED TO MEET OR EXCEED: ASTM C-478 & AASHTO M 199 SPECS.
2. CONCRETE = 4,000 PSI. MINIMUM CEMENT PER ASTM C-478 (6.1)
3. REINFORCED STEEL CONFORMS TO LATEST ASTM A 185 SPECIFICATIONS. 0.15 SQ. IN / LINEAL FT. AND 0.15 SQ. IN (BOTH WAYS) BASE BOTTOM
4. STEEL REINFORCEMENT TO MEET OR EXCEED AASHTO HS-20 LOADING
5. MANHOLE STEPS MEET LATEST OSHA REGULATION 29 CFR1910.27, SECTION 16 OF ASTM SPECIFICATION C478 AND SECTION 10 OF ASTM SPECIFICATION C497
6. BUTYL RUBBER JOINT SEALANT PER ASTM C-990 & ASHTO M-198
7. ONE POUR MONOLITHIC BASE
8. EXTERIOR BITUMINOUS COATING AS REQUIRED



SCITUATE RAY PRECAST  
120 CLAY PIT ROAD  
MARSHFIELD, MA 02050  
PHONE # 1-800-440-0009  
FAX # 781-837-4320

CONTRACTOR:

JOB NAME:

DATE:

DRAWING: SRP-DCB5-EB

DRAWING BY: C.J. SCOTT